

Possible reasons for anomalous fading in alkali feldspars used for luminescence dating of Quaternary deposits

Ivar Jaek^a, Anatoly Molodkov^a, and Valery Vasilchenko^{a,b}

^a Research Laboratory for Quaternary Geochronology, Institute of Geology at Tallinn University of Technology, Ehitajate tee 5, 19086 Tallinn, Estonia; molodkov@gi.ee

^b Institute of Experimental Physics and Technology, University of Tartu, Tähe 4, 51010 Tartu, Estonia; valeri.vassiltsenko@ut.ee

Received 23 May 2007, accepted 27 June 2007

Abstract. According to many publications, alkali feldspars are characterized by specific athermal (anomalous) fading of their thermoluminescence and optically-stimulated luminescence. This phenomenon is manifested as spontaneous decline in luminescence intensity over relatively long (months and years) time after laboratory irradiation, possibly due to tunnelling of electrons from lattice defects and impurities acting as dosimetric traps. It can hamper reliable luminescent dating of Quaternary deposits on the basis of feldspar extractions due to possible unpredictable underestimation of the ages. In this paper we present some experimental results related to the manifestation of the phenomenon. It is found that, in general case, the assumed long-term anomalous fading cannot be connected to electron tunnelling from the deep dosimetric traps. At the same time, some decrease in the dosimetric luminescence signal observable in just irradiated feldspar samples can really be caused by tunnelling. However, the probability of this process quickly goes down, already within some days after irradiation. Interpretation of some other short- and long-term anomalous fading-like effects requires involvement of radiation- and thermo-induced ionic processes.

Key words: luminescence dating, IR-OSL, feldspars, anomalous fading, ionic processes.

INTRODUCTION

Alkali feldspars are extensively used as palaeodosimeters for dating Quaternary deposits. However, it is widely believed that alongside several positive properties, they also have an essential disadvantage. According to many publications (Wintle 1973, 1977; Spooner 1994; Visocekas et al. 1994; Huntley & Lamothe 2001; Wallinga et al. 2001; Balescu et al. 2003; Huntley & Lian 2006), alkaline feldspars are characterized by specific fading of their thermoluminescence (TL) and optically-stimulated luminescence (OSL). Its rate is assumed to vary significantly with samples due to factors which are not yet completely clear. Let us notice that this kind of fading occurs only in the samples irradiated in the laboratory where the routine part of measuring procedures includes several (different authors use different) thermal treatments – preheatings. In naturally irradiated samples the stored energy correlated with the time of burial of the feldspar grains, and hence with the age of the enclosing sediments, is stable. Its lifetime is estimated at about 10^6 – 10^8 or even more years (Mejdahl 1988; Li & Tso 1997). Therefore, the above-mentioned fading is called anomalous (athermal). There is a widespread opinion that anomalous fading (AF) is caused by tunnelling processes in feldspars. According to many

authors (e.g. Spooner 1994; Huntley & Lamothe 2001), tunnelling in feldspars like in other solids (e.g. quartz) can be detected experimentally. However, we do not consider the above causal connection proven. The present paper shows that the results obtained through detailed studies of tunnelling processes do not fit into the frames of this hypothesis. With this in view, we also studied relaxation processes of thermal character occurring in feldspars.

Hitherto studies of anomalous fading mechanism have failed to record one-to-one connection between the crystalline structure of feldspars lattice, detailed chemical composition, stimulation activation energy, and other parameters (Huntley & Lamothe 2001; Huntley & Lian 2006) or parameters characterizing the tunnelling process (our investigations) on the one hand and the rate of fading on the other. What is more, different experiments conducted on one and the same material have yielded fading rates that differ manifold (Huntley & Lamothe 2001).

In order to understand the reasons giving rise to AF, tunnelling directly from feldspars' dosimetrically deep traps, emptying of dosimetric traps at elevated temperatures, and the effect of several preheatings on the kinetics of emptying processes of thermal character were studied in particular detail in the present work.

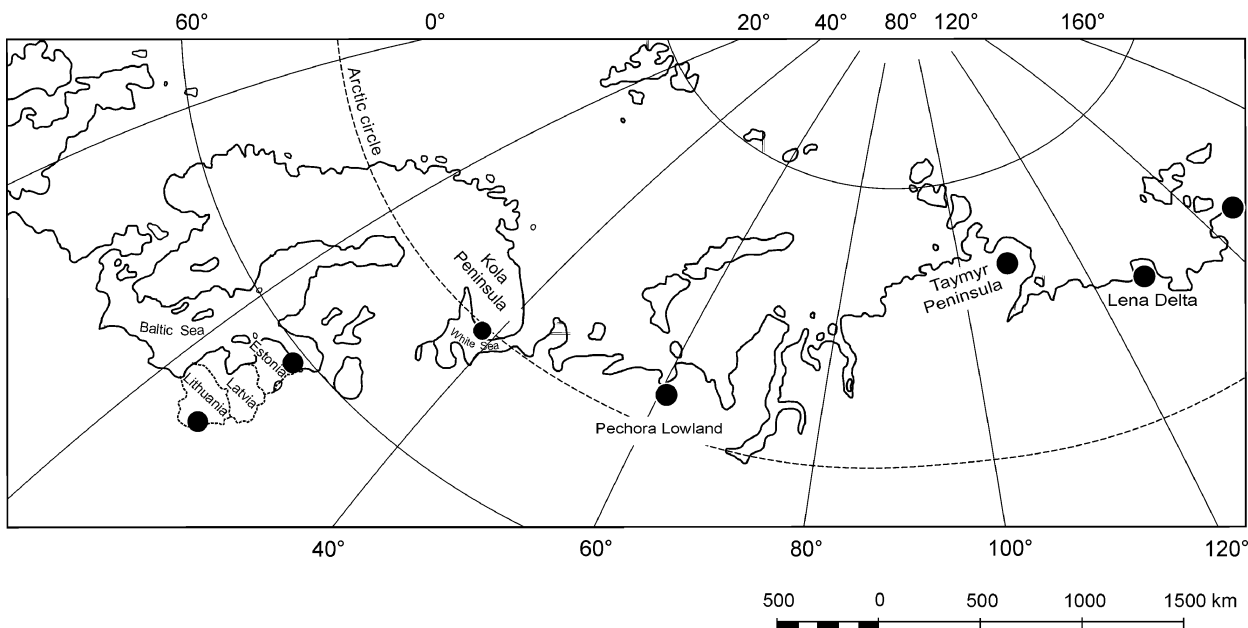

Fig. 1. Map showing the main localities of samples collected for luminescence analysis.

Interpretation of the results requires involvement of ionic processes. In view of this, experimental study of these processes has been started.

MATERIAL AND EQUIPMENT

Feldspars extracted from various samples taken from different areas of Northern Eurasia – from Baltic shores to East-Siberian Sea coast (Fig. 1) – were studied. The equipment used consists of two parts, one of which is

meant for various optical measurements and the other for electrical measurements.

The equipment for optical measurements (Fig. 2) consists of the cryostat with the cooling/heating system of the samples, allowing optical measurements in the range of liquid nitrogen temperature to 450 °C. The cryostat is supplied with an elliptical mirror, where the study sample is in one focus and the photon counter (Hamamatsu H6240) in the other. The TL, OSL, optically stimulated afterglow (OSA), and stimulation spectra are measured, whereas TL and temperature course of OSL can be measured simultaneously. A constant heating rate of 1 °C s⁻¹ is applied. A Xe-lamp serves as a source of stimulating radiation. The necessary wavelength of stimulation (860 nm) is selected by the monochromator, the emission band from 380 to 430 nm – by a combination of 3 mm SZS-22 (blue-green), 3 mm PS-11 (purple), 2 mm FS-1 (violet), and the emission band from 500 to 570 nm – by 2 mm ŽS-18 (yellow) and 3 mm SZS-22 (blue-green) colour glass filters manufactured by the LZOS, JSC (Lytkarino Optical Glass Factory), Russian Federation. The driving of the shutters, the control of the experiment, and the primary processing of the results of the experiment are fulfilled through a PC control unit. For laboratory irradiation, an X-ray source delivering a dose of 0.1 Gy s⁻¹ was used.

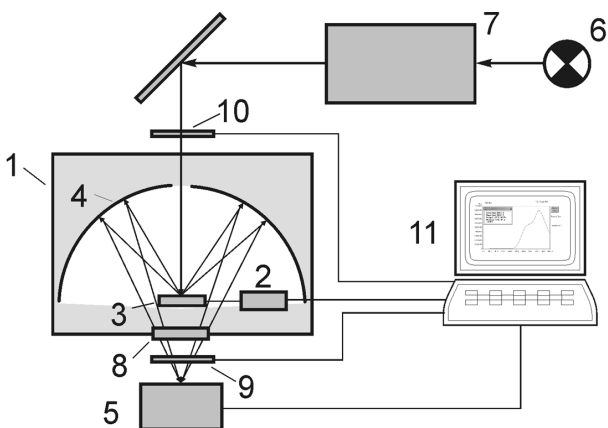

Fig. 2. Measurement equipment. 1, cryostat; 2, cooling/heating system; 3, sample; 4, elliptical mirror; 5, photon counter; 6, Xe-lamp; 7, monochromator; 8, optical filters; 9, 10, shutters; 11, PC control unit.

Ionic conductivity was measured using a dissipation factor meter BM271 (Fig. 3). This device measures the resistance and capacity of a sample in a parallel equivalent scheme. The operating frequency range of

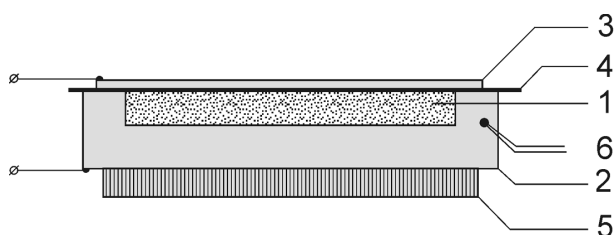

Fig. 3. Ionic conductivity measuring cell. 1, feldspar; 2, cell (lower electrode); 3, upper electrode; 4, mica; 5, heater; 6, thermocouple.

the device is between 100 kHz and 10 MHz. The study sample was sprinkled into a groove, 2 mm deep and 0.79 cm² in area, on a copper plate, which served also as an electrode. Another electrode was pushed from above onto the powder sample, which was situated in the measuring cell. A ca 20 μm thick mica plate between the second electrode and the studied sample eliminated the direct galvanic connection between the electrodes and the study sample. The device allows the heating of the measuring cell up to 300 °C and measurement of the temperature dependence of conductivity. Prior to measurement, each sample was dried for a few minutes at 100 °C. The same device allows also measuring the tangent of dielectric losses.

RESULTS AND DISCUSSION

The tunnelling luminescence

The tunnelling processes in alkali feldspars were separated, and the initial research was carried out by

Visocekas et al. (1994), Spooner (1994), and others. The basic characteristic measured was the tunnelling phosphorescence, which is possible to separate by the cooling of the just irradiated samples. This question was also considered in the recent work of Vasilchenko et al. (2005), where it is shown that the fading of the tunnel afterglow in feldspars follows Becquerel's law and is not directly connected with tunnelling from the deep traps. Besides, as shown by Molodkov et al. (2007b), the characteristic time of attenuation of this luminescence (some hours) is much less than the characteristic time of AF (some months or years).

Because real AF should be connected with the tunnelling from the deep traps, we have estimated in our subsequent experiments the probability of tunnelling recombinations of electrons from these traps. At that, the double-staged (photothermal) character of optical release of electrons from these traps was used (Fig. 4a). For this purpose, it was necessary "to freeze" thermal release of electrons from the IR-excited traps. The observable residual OSL characterizes the probability of the tunnelling process. On the probability of tunnelling recombinations found in such a way we hoped to establish the rate of the expected fading, and hence a possible error in determining the age of the samples.

The probability of the tunnelling is derived from the relationship $\ln(I_{\text{tn}}/I_0)$ vs $1/T$ (Fig. 4b). The slope of the initial part of the plot characterizes the activation energy value ΔE for thermal ionization of the trap, and the value $\ln(I_{\text{tn}}/I_0)$ – the probability of the tunnelling process from the excited state of the centre. From the ground state of the centre this probability is less by a certain number of times since the effective radius of the

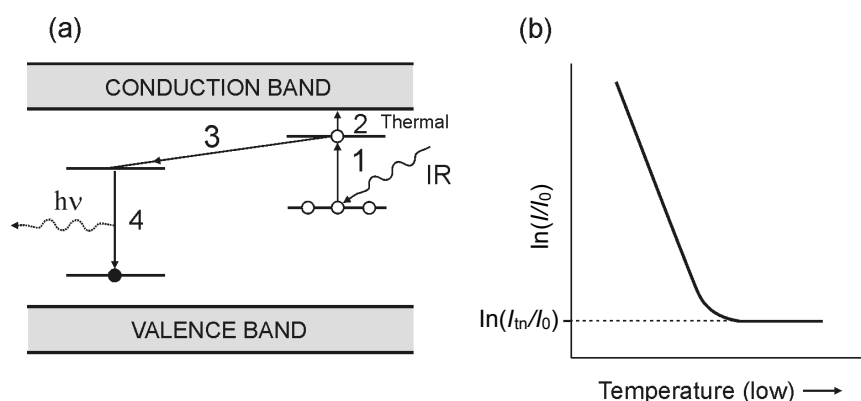

Fig. 4. (a) Simplified energy-level diagram explaining tunnelling at photostimulation (after Kink & Jaek 1972): 1, photoexcitation of the traps; 2, thermal ionization of the excited traps; 3, tunnel recombination of a trapped electron from the excited trap to the ionized luminescence centre; 4, radiative transition from the ionized centre into the basic state. (b) Expected course of the IR-OSL intensity at the lowering of the temperature; I is the intensity at temperature T , I_0 is the initial intensity at room temperature. The dotted line shows the $\ln(I_{\text{tn}}/I_0)$ value in the temperature-independent section of the curve with plateau value at $\ln(I_{\text{tn}}/I_0)$, where I_{tn} is the corresponding IR-OSL intensity. This value characterizes the probability of the tunnelling process from the excited state of the centre.

wave function of the trapped electron is smaller in this state. As a result, the value $\ln(I_{\text{tn}}/I_0)$ should be in accordance with the logarithm from the percentage of age underestimation (Fig. 5). We do not know precisely how these two scales are located with regard to each other, but it is possible to make the following observations.

1. The probability of tunnelling in just irradiated samples is not a constant value. The value, $\ln(I_{\text{tn}}/I_0)$, which characterizes this probability, decreases during a couple of days from -2.5 to -3.5 (depends on the sample) to -5 and continues to fall (Fig. 6). The same effect causes the heating of the sample. The minimum level of the $\ln(I_{\text{tn}}/I_0)$ value is reached after heating above 230°C . This implies that such reduction of the signal is not caused by the tunnelling itself because the heating occurs very quickly, and the probability of the tunnelling process does not depend on temperature.
2. Our experiments show that for the materials investigated the minimal value of $\ln(I_{\text{tn}}/I_0)$ is at the same level, about -7 . Similar results have been received for the yellow-greenish band of luminescence as well.
3. The preheating (before laboratory irradiation) of the majority of samples up to 800°C and higher results in an increase in the probability of tunnelling by an order of magnitude (Molodkov et al. 2007b). At the same time, the data by Mejdahl (1983) on dating ancient ceramics by the feldspar inclusion method show coincidence of the results of luminescence dating with

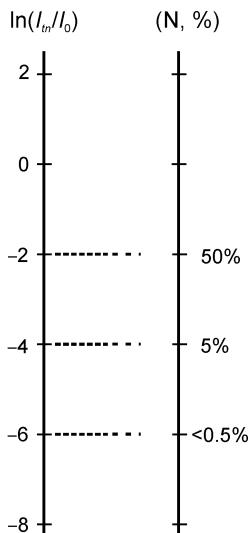

Fig. 5. An expected relationship between the probability of tunnelling and a possible error (underestimation) in determining the age of the sample. Scales are located approximately with regard to each other. N,% is the age underestimation, in per cent, I is the intensity at temperature T , and I_0 is the initial intensity at room temperature (see Fig. 4 for details).

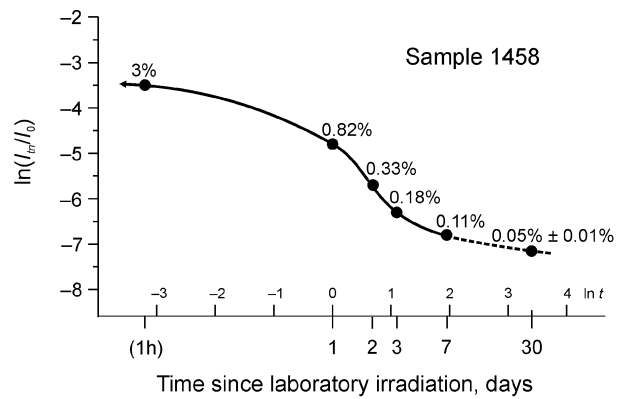

Fig. 6. Tunnelling probability as a function of time since laboratory irradiation for typical feldspar sample from the Scandinavian source region; I_0 is the initial intensity at room temperature, I_{tn} is the plateau value in the temperature-independent section of the course of the IR-OSL intensity recorded with decrease in temperature down to liquid nitrogen temperature. Figures at the curves are the contributions of the tunnel luminescence to the OSL signal, in per cent. The last point was obtained by extrapolation of the curve to the time of 30 days. Over 1 month the tunnel luminescence comprises ca 0.05% of the IR-OSL signal value.

the archaeological data. It means that although in this case manufacturing of ceramics is connected with rather high-temperature heating, fading is not essential. From these data it follows that the scales in Fig. 5 should be located so that the value $\ln(I_{\text{tn}}/I_0) = -4$ corresponds to age underestimation of less than 5%.

Relaxation processes

Relaxation processes were studied with the aim of finding out reasons for AF-like manifestation, because tunnelling processes cannot provide a controversy-free explanation of the problem. In principle, there are several possibilities. The purpose of our investigations was to make a choice between the following ones:

1. Anomalous fading is only seemingly anomalous, because traditional methods used to determine the depth of the traps may yield incorrect results in a certain type of energy-band schemes (Chen et al. 2000).
2. Hole processes take place, which cause changes in the probability of radiative and non-radiative recombinations and which themselves occur without radiation. Such processes lead to apparent fading, because population of the dosimetric traps does not necessarily change with these processes (Fok 1964).
3. There occur radiation- and thermostimulated ionic processes, which alter the structure of centres and

thus also their essential parameters, like trapping and release possibilities of the charge carriers, but probably also their optical characteristics. It is highly possible that after elimination of the agent stimulating the ionic process (end of irradiation, cooling down to initial temperature, etc.) the structure of centres recovers back to the initial state.

Let us analyse the above three possibilities in more detail in the light of experimental results obtained on feldspars.

X-ray luminescence quenching

Figure 7 shows the temperature dependence of X-ray luminescence intensity during cooling from 450 °C to room temperature in sample No. 1580 (curve 1) taken from the V1 section at the Voka site, northeastern Estonia (Molodkov 2007; Molodkov et al. 2007a). The figure also presents the TL curve (2) of that object. It is evident that the TL dosimetric peaks are in the region of intensive thermal quenching of luminescence. As is known, there are two types of that kind of quenching – internal and external. In the case of internal quenching, the analysis of TL curves will result in an incorrect ionization activation energy value E' . At that

$$E' = E_{\text{ion}} - E_{\text{quen}}$$

where E_{ion} is the real ionization energy, E_{quen} is the activation energy of quenching (see Antonov-Romanovskij 1966). In the case of external quenching,

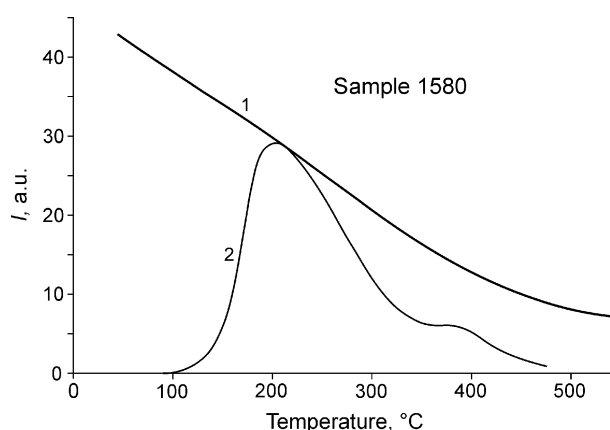

Fig. 7. Thermal quenching of X-ray luminescence (sample No. 1580 from the Voka section): 1, dependence of X-ray luminescence intensity on temperature; 2, TL curve.

the obtained activation energy value is correct; however, in parallel with the quenching of dosimetric traps there occurs the hole process, which changes the concentration of recombination centres.

Thermo-optical bleaching (TOB)

Figure 8 presents the results of simultaneous TL and OSL measurements in the X-rayed (a) and natural (b) feldspar sample No. 1580. We and other authors (see, e.g., Duller & Bøtter-Jensen 1993) have obtained similar curves characterized by the absence of the fall in

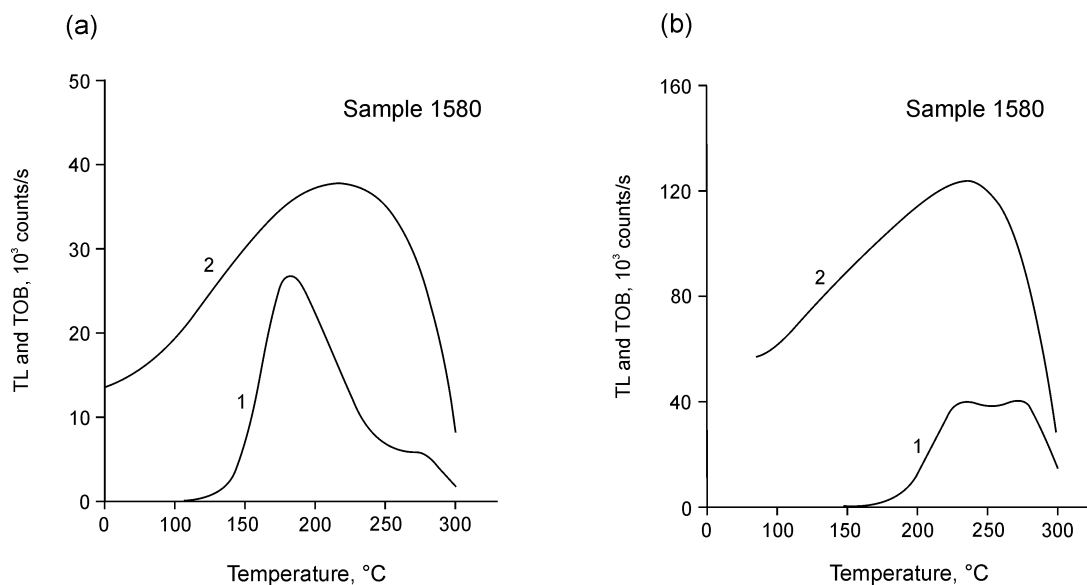

Fig. 8. Thermo-optical bleaching (TOB) of irradiated (a) and natural (b) aliquots of sample No. 1580: 1, TL; 2, TOB. X-ray excitation at room temperature.

the TOB curve in the region of the X-ray-induced TL peak around 180°C. Similar results were also obtained when measuring other samples.

In the case of standard band models, the electron process in the region of the X-ray-induced TL peak, which in the present case is also the dominating peak, would lead to a significant fall in the IR-optically stimulated luminescence (IR-OSL) intensity as a result of an abrupt decrease in the number of ionized radiation centres. One possible explanation could be the occurrence of a hole process in this region, which is also indicated by the X-ray luminescence thermal quenching results. However, it should be pointed out that in the present case this does not lead to the reduction of IR-stimulated luminescence, which means that the possibility of apparent fading is excluded. Since there is no decline in the IR-OSL intensity in the region of the TL peak induced by X-rays (or by some other kind of ionizing radiation), the concentration of dosimetric centres in this region does not change either. This allows determination of the adjusted parameters of dosimetric traps via the IR-OSL relaxation at elevated temperatures.

IR-stimulated luminescence relaxation at 400 and 450 K

The band model of solids, which contains only one type of electron centres (feldspar dosimetric centres in the present case), provides a possibility of establishing the depth of these traps by determining the decrease in their concentrations at two different temperatures (Antonov-Romanovskij 1966).

As is known, the probability of thermal ionization of a centre at certain temperature, p_T , manifests itself when

$$p_T = p_0 e^{-E/kT_1},$$

where p_0 is a constant, E is the thermal ionization activation energy of the centre, k is the Boltzmann constant, T is absolute temperature.

For two different temperatures we obtain

$$p_1 = p_0 e^{-E/kT_1} \text{ and } p_2 = p_0 e^{-E/kT_2}.$$

From this it follows that

$$\frac{p_1}{p_2} = e^{-E/k(1/T_1 - 1/T_2)}.$$

The thermal ionization activation energy of the centre can then be expressed as follows:

$$E = \frac{k \ln(p_2/p_1)}{1/T_1 - 1/T_2},$$

where p_1 and p_2 can be determined through the changes that take place in the concentration of the studied centres with time. In our case, the measure of concentration is the intensity of IR-stimulated luminescence, but there arises a difference as to the mono- and bimolecular kinetics. In the case of mono-molecular kinetics,

$$I = I_0 e^{-t/\tau},$$

where I is the luminescence intensity, I_0 is the initial luminescence intensity, and $\tau = 1/p$ is the lifetime of the centre.

In the case of bimolecular kinetics,

$$I = I_0 / (1 + \omega t),$$

where $\omega = \alpha p$, with α being a constant that depends only on effective cross-sections of charge-carriers for trapping and recombination. In both cases, from these equations it is possible to express p_1/p_2 through the IR-OSL intensities. This allows us to determine the E value, and on the basis of lifetime at one temperature (e.g. 450 K), it is possible to calculate the lifetime at some other temperature (e.g. room temperature). The experiments carried out with a series of feldspar samples yielded surprising results – activation energy $E \approx 0.6\text{--}0.7$ eV, while the lifetime τ calculated for room temperature is equal to 1–2 years (depending on the type of kinetics), which is too low in comparison with the known values of about $10^6\text{--}10^8$ years.

To our mind, the above shows that in the studied relaxation process alongside the emptying of dosimetric traps there also occurs an additional process, which could be either the hole or ionic process.

Figure 9 presents a plot of IR-OSL intensity vs time for the case where the material (sample No. 1580) was X-rayed at room temperature and then measured at 400 K (127°C). This curve can well be described by the equation of Huntley & Lamothe (2001):

$$I = I_c \left(1 - g \log \frac{t}{\tau_c} \right),$$

where g is the fading parameter expressed as per cent per decade, τ_c is the time elapsed from the end of irradiation, and I_c is the intensity of luminescence at that moment of time. The best fit is achieved when $g = 23\%$ per decade and $\tau_c = 100$ min. When the same sample was stored after X-raying at room temperature before the measurement, no intensity decrease was observed within the same time range. In other words, the fading parameter in the above equation depends on the temperature! In the case of tunnelling processes where the validity of this equation is considered a proof

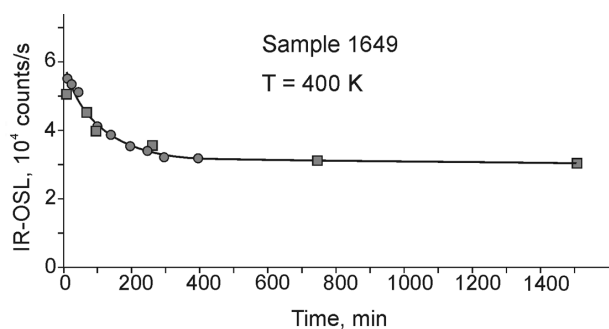

Fig. 9. Temporal course of OSL intensity at 400 K (sample No. 1649 from the Voka section). X-ray excitation at room temperature. The squares denote the intensities calculated according to the equation of Huntley & Lamothe (2001) with the fading parameter $g = 23\%$ per decade.

of the essential role which these processes play in athermal fading, there cannot be such a dependence.

On the other hand, the segment of the quenching curve under consideration can be described as the sum

of two exponents with their characteristic times being 160 and 1200 min, respectively. These processes occur on the background of a third, still slower process, i.e.

$$I(t) = I_1(t) + I_2(t) + I_3(t).$$

The function $I_3(t)$ is practically constant in the time interval under consideration. With a very high probability $I_3(t)$ describes the emptying due to the thermal ionization of the deepest component of dosimetric doublet at given temperature (400 K).

Excellent agreement between cross-dating results obtained on 20 middle and late Pleistocene samples by three different methods (electron spin resonance (ESR), OSL, and IR-OSL) using three different minerals – feldspar (dated by IR-OSL), quartz (by OSL), and biogenic carbonate (by ESR) for the range of the last 307 000 years (Table 1) allows us to conclude that the real depth of the feldspar dosimetric traps might be 1.7–2.0 eV and the lifetime ca 10^6 – 10^7 or even more years at the ambient temperature of $+5^\circ\text{C}$.

Table 1. Mollusc-based ESR, feldspar IR-OSL, and quartz OSL cross-dating results

No.	Section	Location	Sampling depth, m	Mollusc-based ESR age* ($\times 1000$ yr)	Feldspar IR-OSL age* ($\times 1000$ yr)	Quartz OSL age* ($\times 1000$ yr)
1	U-XXII	~67.9N 60.1E	7.0	72.0 ± 4.8^a	74.7 ± 8.3^a	–
2	U-VII	~67.8N 60.7E	6.5	90.3 ± 10.9^b	88.2 ± 5.4^b	–
3	Varzuga	~66.4N 36.6E	16.0	103.0 ± 4.2^c	104.0 ± 8.3^c	–
4	U-VII	~67.8N 60.7E	11.0	107.6 ± 12.4^b	109.8 ± 6.9^b	–
5	Vilkiškės	~54.8N 25.4E	14.5	–	–	129.0 ± 24.0^d
6	Vilkiškės	~54.8N 25.4E	14.0	–	136.7 ± 8.8^e	–
7	Vilkiškės	~54.8N 25.4E	14.2	–	147.1 ± 9.4^e	–
8	Vilkiškės	~54.8N 25.4E	17.8	–	–	150.7 ± 5.8^d
9	Vilkiškės	~54.8N 25.4E	25.7	–	–	211.0 ± 16.0^d
10	Vilkiškės	~54.8N 25.4E	29.5	–	230.2 ± 16.2^e	–
11	Vilkiškės	~54.8N 25.4E	33.0	–	273.3 ± 16.0^e	–
12	Vilkiškės	~54.8N 25.4E	34.5	–	307.1 ± 17.4^e	–
13	Chavan'ga	~66.0N 37.8E	4.0	–	63.6 ± 8.0^f	–
14	Chavan'ga	~66.0N 37.8E	8.5	99.0 ± 7.6^f	–	–
15	Strel'na	~66.0N 38.5E	6.5	–	85.6 ± 6.6^f	–
16	Strel'na	~66.0N 38.5E	25.8	90.4 ± 6.7^f	–	–
17	Strel'na	~66.0N 38.5E	29.8	–	101.9 ± 12.2^f	–
18	Strel'na	~66.0N 38.5E	32.2	111.5 ± 12.4^f	–	–
19	Ludyany	~66.3N 39.9E	8.3	–	80.5 ± 7.0^f	–
20	Ludyany	~66.3N 39.9E	12.7	85.5 ± 6.6^f	–	–

* Mollusc-based ESR and feldspar IR-OSL ages determined at the Research Laboratory for Quaternary Geochronology, Institute of Geology at Tallinn University of Technology, quartz OSL ages at the Luminescence Dating Unit of the Department of Radioisotopes, Institute of Physics, Silesian University of Technology.

^a Molodkov & Bitinas (2006), ^b Bolshiyarov (2006), ^c Molodkov & Yevzerov (2004), ^d Fedorowicz (2003), ^e Satkūnas & Molodkov (2005), ^f Korsakova et al. (2004).

The effect of thermal treatment on some optical properties of feldspars and parameters of luminescence kinetics

The results described above suggest that the results of heating cannot only be explained with the release, recombination, and redistribution of electrons and holes between different types of traps. The relevant additional processes are relatively slow ($\tau \approx 2$ h at 400 K). On this basis it is reasonable to assume that it is an ionic process, which is at least partially radiation-induced (Zakis et al. 1980). Changes in the lattice crystalline structure are excluded in the temperature regions under consideration. Several phenomena are in agreement with the hypothesis. These have been described earlier, among those:

1. change in sensitivity to irradiation – under moderate heating (100–250°C) (Jaek et al. 2007);
2. changes in the ratio of violet to yellow-greenish emission bands in the case of the same procedure (Molodkov et al. 2007b).

Heating a feldspar sample at 450 K (177°C) before X-raying yields an analogous result (Fig. 10). The sensitivity appears to have increased and the X-rayed TL peak has shifted compared to the same sample X-rayed before heating.

The results presented in Figs 11 and 12 are even more directly associated with the effect of thermal

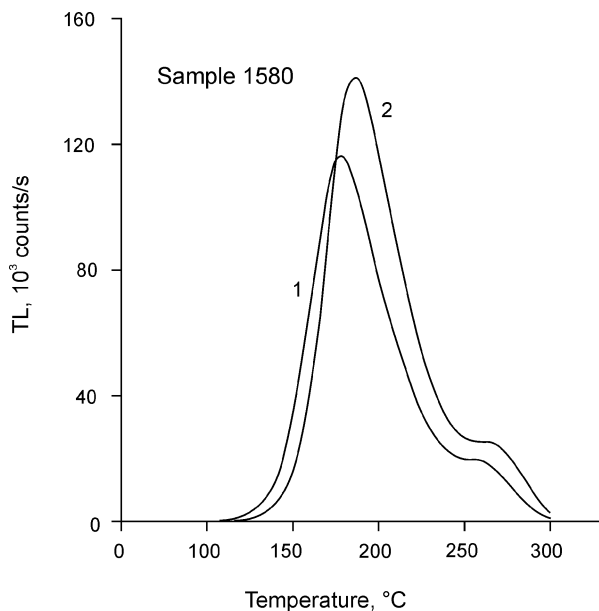

Fig. 10. TL curves of sample No. 1580 after X-ray excitation at room temperature. 1, the sample has been heated before X-ray excitation at 400 K (127°C) for 24 h; 2, non-heated sample.

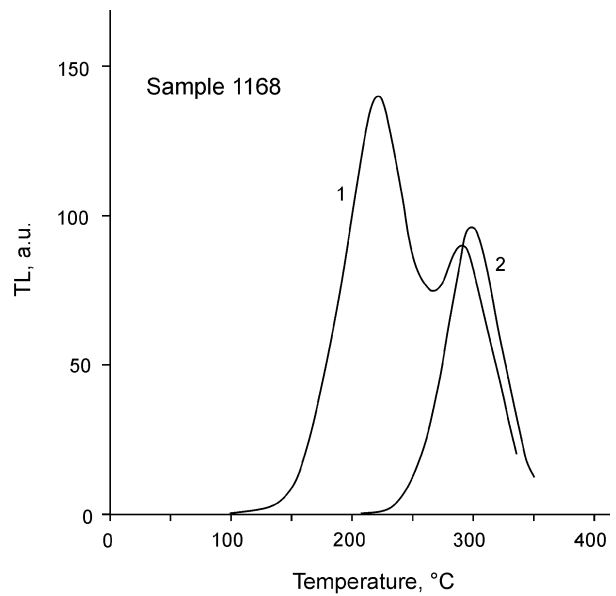

Fig. 11. TL curves of natural feldspar (sample No. 1168). 1, without preheating; 2, preheated at 450 K (177°C) for 40 min.

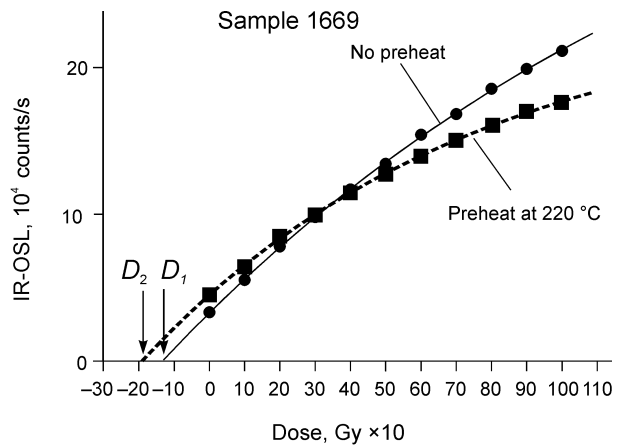

Fig. 12. Dose-response curve for sample No. 1669 (from northwestern Lithuania) showing the effect of 5 min preheat at 220°C after laboratory irradiation (dotted line) and the dose-response curve for the same sample stored 30 days after laboratory irradiation and measured without preheating (solid line). The value of the reconstructed equivalent palaeodose D_2 is obviously overestimated if the preheating procedure is used after laboratory irradiation. Usually, a similar behaviour is also observed after preheating at 160°C for 5 min. Delayed measurements after more than 20 h storage eliminates this effect.

treatment. Figure 11 shows a shift of high-temperature TL peak and an increase in the amplitude, which are related to heating, while Fig. 12 displays crossing dose-dependence curves and an obviously overestimated value of the reconstructed equivalent palaeodose D_2 after preheating the sample at 220°C for 5 min after laboratory irradiation.

The effect of heating is also revealed in OSL characteristics, first of all in the thermal activation energy value $\Delta\varepsilon$ for optically excited dosimetric centres, which can be found as the rise of the curve in co-ordinates $\ln(I/I_0)$ vs $(1/T)$. Relevant results are presented in Fig. 13. The numerical value of $\Delta\varepsilon$ is about 0.1 eV for an unheated sample and about 0.18 eV for a heated sample. Let us remind that at low temperatures (around 150 K) the $\Delta\varepsilon$ values are in the range of 0.40–0.07 eV (see Vasilchenko et al. 2005). The results can be interpreted as changes in the structure of dosimetric centres, as a result of which the distance of the excited level of the dosimetric centres from the bottom of conduction band changes. At the same time, identical thermal treatments within the limits of the measurement error do not affect stimulation spectra. All these phenomena and facts seriously refer to

the great role of ionic processes in the relaxation of stored energy and/or to the changes in the conditions of radiative relaxation of the electrons released from dosimetric traps.

The above allows us to conclude that long-term (some months or years) anomalous (athermal) fading as a phenomenon, which is usually associated with tunnelling processes, needs not to be associated with tunnelling at all. One only has to give up preheating in dating protocols and replace it, for instance, with storing at room temperature for a month after laboratory irradiation. This time is needed for the relaxation of short-term tunnelling and radiation-induced ionic processes. The data presented in Fig. 6 evidently demonstrate the temporal probability of the relaxation of tunnelling processes at room temperature.

Ionic processes

Ionic conductivity was determined as the reciprocal value of equivalent resistance, and the tangent of dielectric losses as

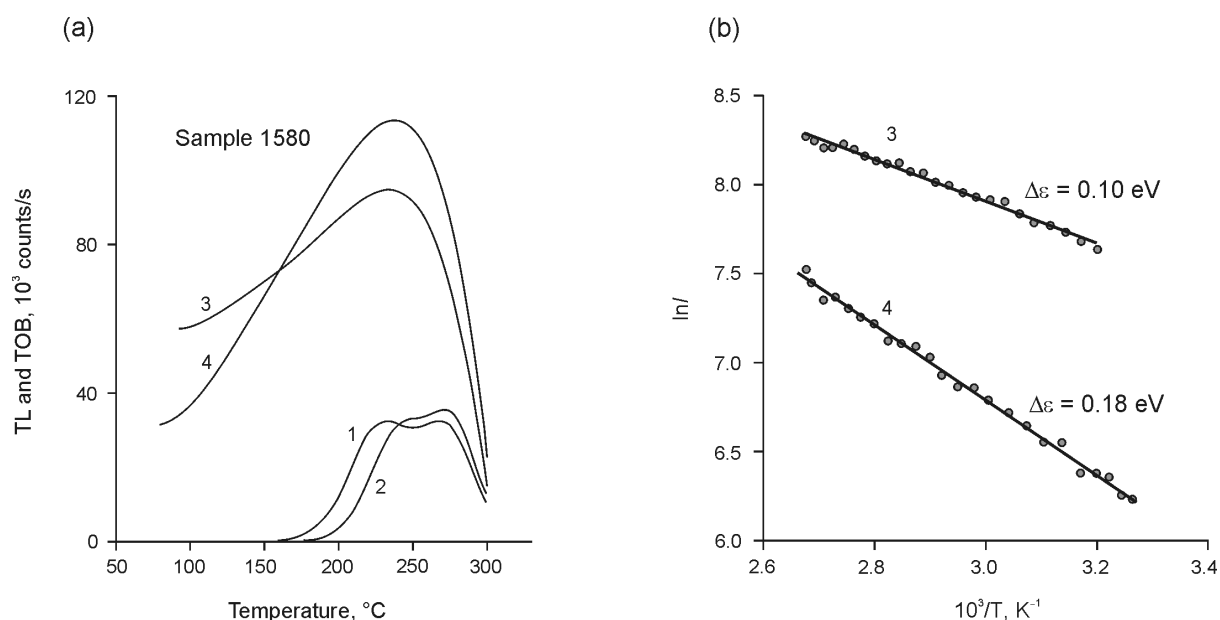

Fig. 13. (a) TL (1, 2) and thermo-optical bleaching (TOB) (3, 4) of natural feldspar sample No. 1580 from the Voka section: 1, TL of the non-heated sample; 2, TL of the sample heated at 110°C for 20 h; 3, TOB of the non-heated sample; 4, TOB of the heated sample. (b) Results of the treatment of the temperature dependencies of TOB (curves 3 and 4 on the left figure) plotted in the co-ordinates $\ln I$ vs $1/T$.

$$\tan \delta = \frac{1}{2\pi fRC},$$

where f is the frequency, C is the sample's capacity, and R is its equivalent resistance. As is known, the total conductivity (σ) is the sum of electron (σ_e) and ionic (σ_i) conductivities: $\sigma = \sigma_e + \sigma_i$. If $\sigma_e \ll \sigma_i$, then the total conductivity temperature dependence is described by the well-known Arrhenius equation (see Hooper 1978):

$$\sigma_i = (\sigma_0/T)\exp(-E_i/kT).$$

Practically all the feldspar samples measured by us are characterized by high conductivity $(2-3) \times 10^{-6}$ Sm/cm. The fact that the temperature dependence of conductivity is in very good compliance with the Arrhenius equation (Fig. 14) demonstrates that we are dealing with ionic conductivity. For most of the materials measured its activation energy constituted a few hundredths of an electron volt; feldspar sample No. 1580 served as the only exception (see Fig. 14).

All the above suggests that there is an enormous amount of weakly tied ions in feldspars. While moving, these ions can change the nearest neighbourhood of both the dosimetric traps and luminescence centres, particularly at elevated temperatures.

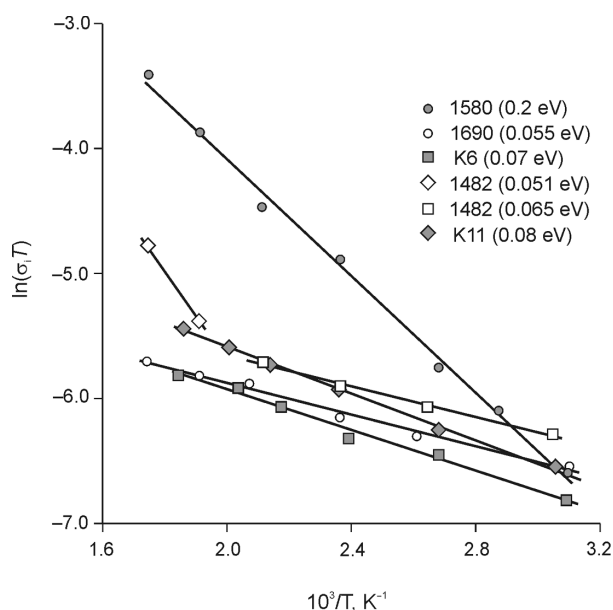

Fig. 14. Ionic conductivity in different feldspar samples. Activation energy values (E_i) are given in brackets.

CONCLUSIONS

- As a result of the study it is possible to assert that, in the general case, the fading with the characteristic time of some months or years cannot be connected to electron tunnelling from the deep traps.
- In order to give an adequate explanation to the fading under discussion, additional processes should evidently be taken into consideration. According to our data, these are ionic processes. Direct measurement of the characteristics of ionic processes shows the presence of a great number of weakly tied ions in feldspars; while moving, these ions can cause changes in the properties of impurity centres resulting in fading-like effects.
- Besides fading-like effects, ionic processes appear also in several other phenomena (e.g. changes in OSL thermal activation energy), which are caused by preheatings used in most of dating protocols.
- It can be assumed that some decrease in the dosimetric TL/OSL signal observable in feldspar samples after laboratory irradiation can really be caused by tunnelling. However, the probability of this process quickly goes down, already within some days after laboratory irradiation (Fig. 6).
- At the same time, it is probable enough that in some feldspar modifications, particularly in those of volcanic origin, the minimum level of tunnelling can surpass the level, after which the age underestimation starts to increase noticeably.

ACKNOWLEDGEMENTS

The authors are grateful to Tatyana Balakhnichova and Marina Osipova for their contribution to the laboratory work reported here, and to Helle Kukk for improving the English text. The authors also wish to thank Prof. D. Huntley who provided them with some feldspar samples. This research was supported by grant No. 6112 from the Estonian Science Foundation and by Estonian State Target Funding Project No. 0320080s07.

REFERENCES

- Antonov-Romanovskij, V. V. 1966. *Kinetika fotoluminestsentsii kristallofosforov* [Kinetics of crystal phosphor photoluminescence]. Nauka, Moscow, 324 pp. [in Russian].
- Balescu, S., Lamothe, M., Mercier, N., Huot, S., Balteanu, D., Billard, A. & Hus, J. 2003. Luminescence chronology of

- Pleistocene loess deposits from Romania: testing methods of age correction for anomalous fading in alkali feldspars. *Quaternary Science Reviews*, **22**, 967–973.
- Bolshiyarov, D. Yu. 2006. *Passivnoe oledenenie Arktiki i Antarktiki [Passive glaciation of the Arctic and Antarctic]*. AAR, St Petersburg, 295 pp. [in Russian].
- Chen, R., Leung, P. L. & Stokes, M. J. 2000. Apparent anomalous fading of thermoluminescence associated with competition with radiationless transitions. *Radiation Measurements*, **32**, 505–511.
- Duller, G. A. T. & Bøtter-Jensen, L. 1993. Luminescence from potassium feldspars stimulated by infrared and green light. *Radiation Protection Dosimetry*, **47**, 683–688.
- Fedorowicz, St. 2003. Thermoluminescence method: outline of history, foundations, principle, possibilities, perspectives and limitations. *Geologija*, **41**, 28–35.
- Fok, M. V. 1964. *Vvedenie v kinetiku lyuminescentsii kristalloy fosforov [Introduction to the kinetics of crystal phosphor luminescence]*. Nauka, Moscow, 283 pp. [in Russian].
- Hooper, A. 1978. Fast ionic conductors. *Contemporary Physics*, **19**, 148–150.
- Huntley, D. J. & Lamothe, M. 2001. Ubiquity of anomalous fading in K-feldspars and the measurement and correction for it in optical dating. *Canadian Journal of Earth Sciences*, **38**, 1093–1106.
- Huntley, D. J. & Lian, O. B. 2006. Some observations on tunnelling of trapped electrons in feldspars and their implications for optical dating. *Quaternary Science Reviews*, **25**, 2503–2512.
- Jaek, I., Molodkov, A. & Vasilchenko, V. 2007. Luminescent manifestation of tunnel and ionic processes in alkali feldspars. *Journal of Applied Spectroscopy*, **74**, 321–326 [in Russian, with English summary].
- Kink, M. & Jaek, I. 1972. The tunnelling from excited states of Tl^0 -centres in KCl crystals. *Transactions of the Institute of Physics and Astronomy of the Academy of Sciences of the ESSR*, **39**, 316–318 [in Russian, with English summary].
- Korsakova, O. P., Molodkov, A. N. & Kolka, V. V. 2004. Geological stratigraphic position of Upper Pleistocene marine sediments in the southern Kola Peninsula: evidence from geochronological and geological data. *Doklady Earth Sciences*, **398**, 908–912.
- Li, S.-H. & Tso, M.-Y. W. 1997. Lifetime determination of OSL signals from potassium feldspar. *Radiation Measurements*, **27**, 119–121.
- Mejdahl, V. 1983. Feldspar inclusion dating of ceramics and burnt stones. *PACT*, **9**, 351–364.
- Mejdahl, V. 1988. Long-term stability of the TL signal in alkali feldspars. *Quaternary Science Reviews*, **7**, 357–360.
- Molodkov, A. 2007. IR-OSL dating of uranium-rich deposits from the new late Pleistocene section at the Voka site, North-Eastern Estonia. *Quaternary Geochronology*, **2**, 208–215.
- Molodkov, A. & Bitinas, A. 2006. Sedimentary record and luminescence chronology of the Lateglacial and Holocene aeolian sediments in Lithuania. *Boreas*, **35**, 244–254.
- Molodkov, A. & Yevzerov, V. 2004. ESR/OSL ages of long-debated sub-till fossil-bearing marine deposits from the southern Kola Peninsula: stratigraphic implications. *Boreas*, **33**, 123–131.
- Molodkov, A., Bolikhovskaya, N., Miidel, A. & Ploom, K. 2007a. The sedimentary sequence recovered from the Voka outcrops, northeastern Estonia: implications for late Pleistocene stratigraphy. *Estonian Journal of Earth Sciences*, **56**, 47–62.
- Molodkov, A., Jaek, I. & Vasilchenko, V. 2007b. Anomalous fading of IR-stimulated luminescence from feldspar minerals: some results of the study. *Geochronometria*, **26**, 11–17.
- Satkūnas, J. & Molodkov, A. 2005. Middle Pleistocene stratigraphy in the light of data from the Vilkiškės site, Eastern Lithuania. *Polish Geological Institute Special Papers*, **16**, 94–102.
- Spooner, N. A. 1994. The anomalous fading of infra-red stimulated luminescence from feldspars. *Radiation Measurements*, **23**, 625–632.
- Vasilchenko, V., Molodkov, A. & Jaek, I. 2005. Tunnel processes and anomalous fading in natural feldspars extracted from Quaternary deposits. *Journal of Applied Spectroscopy*, **72**, 218–223.
- Visocekas, R., Spooner, N. A., Zink, A. & Blanc, P. 1994. Tunnel afterglow, fading and infrared emission in thermoluminescence of feldspars. *Radiation Measurements*, **23**, 377–385.
- Wallinga, J., Murray, A. S., Duller, G. A. T. & Törnqvist, T. E. 2001. Testing optically stimulated luminescence dating of sand-sized quartz and feldspar from fluvial deposits. *Earth and Planetary Science Letters*, **193**, 617–630.
- Wintle, A. G. 1973. Anomalous fading of thermoluminescence in mineral samples. *Nature*, **245**, 143–144.
- Wintle, A. G. 1977. Detailed study of a mineral exhibiting anomalous fading. *Journal of Luminescence*, **15**, 385–393.
- Zakis, Yu. R. 1980. *The simplest thermal defects in glasses*. In *Fizika i khimiya stekloobrazuyushchikh sistem [Physics and chemistry of glass-forming systems]* (Zakis, Yu. R. et al., eds), pp. 3–36. Latvīskij gos. un-t im. Petra Stuchki, NII fiziki tverdogo tela, Riga LGU [in Russian].

Anomaalse feedingu võimalikest põhjustest kvaternaarse setete luminescentsdateerimiseks laialt kasutatavates päevakivides

Ivar Jaek, Anatoli Molodkov ja Valeri Vassiltšenko

Paljude publikatsioonide andmeil on leelispäevakividele iseloomulik spetsiifiline atermaalne (anomaalne) feeding, mis ilmneb nii nende termoluminescentsis (TL) kui ka optiliselt stimuleeritud luminescentsis (OSL). See nähtus väljendub pärast laboratoorset kiiritamist toimivas luminescentsignaali spontaanses, küllaltki pikka karakterset aega omavas languses ja on väidetavalt põhjustatud elektronide tunnelleerimisest dosimeetristelt haardenivoodelt. Selline feeding raskendab kvaternaarse setete usaldusväärset dateerimist neist setetest ekstraheeritud leelispäevakivide abil, põhjustades setete vanuse alahindamist. Feedingu kiirus on prooviti väga erinev, seega ennustamatu.

Artiklis on esitatud rida katsetulemusi, mis on seotud anomaalse feedingu põhjuste selgitamisega leelispäevakivides. On näidatud, et üldjuhul ei saa pikaajalist anomaalset feedingut siduda elektronide tunnelleerimisega sügavatelt haardenivoodelt. Küll aga võib tunnelleerimisega olla osaliselt seotud luminescentsignaali vähenemine vahetult peale laboratoorset kiiritamist. Siiski langeb selle protsessi tõenäosus juba mõne päevaga pärast kiiritamist alla selle piiri, kus ta võiks põhjustada vaadeldavat feedingut. Vähegi pikemaajaliste (aga ka lühiajaliste) anomaalse feedingu taoliste nähtuste interpretatsioon nõuab termo- ja radiatsioon-indutseeritud ioonprotsesside kaasamist. Sellise uurimissuuna arendamist on käesolevas artiklis alustatud.